

FITTING INSTRUCTION

Clamp mark in acc. with		Cables joining
ISO	PN	
1	L	Left directional lights
2	+	Rear fog lights
3	31	Ground
4	R	Right directional lights
5	58R	Right side parking lights
6	54	Stoplights
7	58L	Left side parking lights

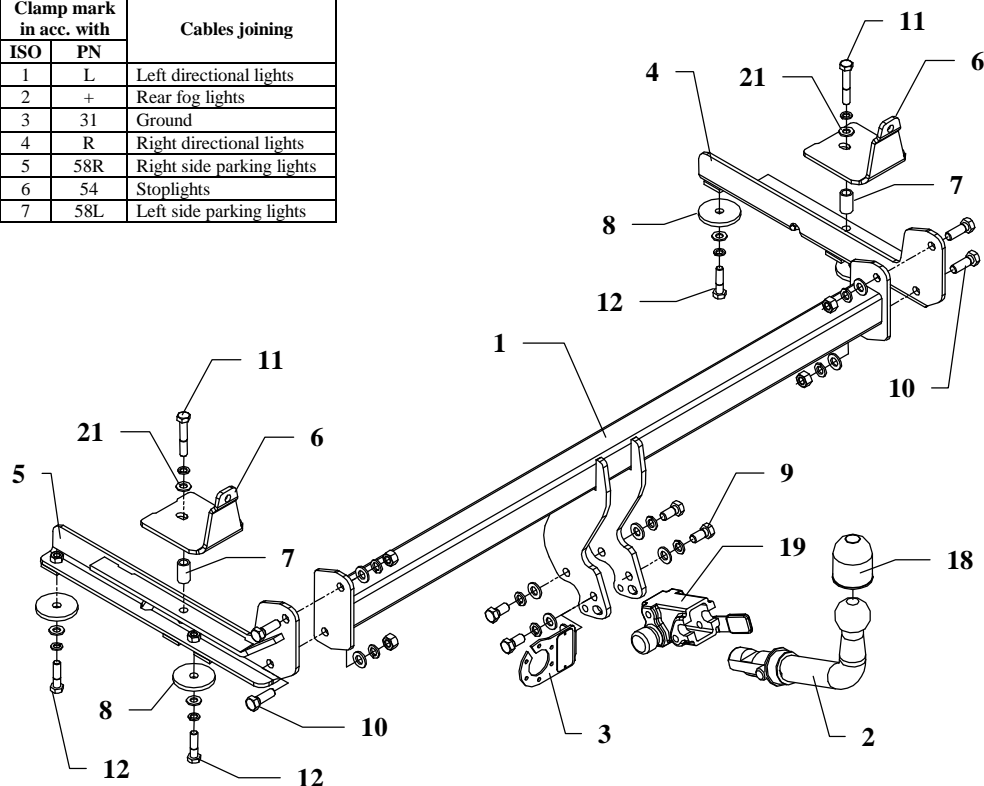

This towing hitch is designed to assembly in following car:
HONDA ACCORD 4-5 doors, produced since 1993 till 10.1998,
 catalogue no. **Y22A** and is prepared to tow trailers max total weight
1400 kg and max vertical load **70 kg**.

From manufacturer

Thank you for buying our product. Their reliability has been confirmed in many tests. Reliability of towing hitch depends also on correct assembly and right operation. For this reasons we kindly ask to read carefully this instruction and apply to hints.

The towing hitch should be install in points described by a car producer.

Fitting instructions

1. To install this towing hitch you have to disassemble a bumper.
2. From boot take out carpet, unscrew plastic cover of rear part and pull side upholstery.
3. From below the car in chassis members are holes blind with plastic plugs – pull out this plugs.
4. To chassis members slip side brackets (pos. 4 and 5) and loosely fix it as shown in drawing.
5. Inside boot remove plastic plug, slide distance sleeves (pos. 7), put elements pos. 6 and fix as shown in drawing.
6. Between installed brackets pos. 4 and 5 insert main bar of towing hitch pos. 1 and fix using bolts M12x35mm (pos. 10).
7. Cut fragment of bumper (use template).
8. After cut, install bumper to a car.
9. Fix body of the automat (pos. 19) and the socket plate (pos. 3) using bolts M12x25mm (pos. 9) from equipment. Place tow-ball (pos. 2) according to supplied instruction.
10. Tighten all bolts according to the torque shown in the table.
11. Connect electric wires of 7-bolts socket according to the instruction of the car. (Recommend to make at authorized service station).
12. Complete the paint coating damaged during installation.

Torque settings for nuts and bolts (8,8):

M6 - 11 Nm	M8 - 25 Nm	M10 - 50 Nm
M12 - 87 Nm	M14 - 138 Nm	M16 - 210 Nm











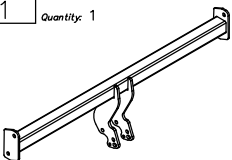



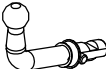

NOTE

After install the towing hitch you should get adequate note in registration book (at authorised service station).The car should be equipped with:

- Indicators
- Tow mirrors

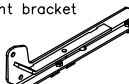
After 1000km of exploitation check all bolts and nuts. The ball of towing hitch must be always kept clear and conserve with a grease.

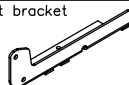
Towing hitch equipment:

Pos. 1 Name: Main bar Quantity: 1	Pos. 6 Name: Bend fish-plate Quantity: 2	Pos. 12 Name: Bolt 8,8 B Quantity: 4 Dim.: M10x40mm	Pos. 18 Name: Ball cover Quantity: 1
	Pos. 7 Name: Distance sleeve Quantity: 2 Dim.: Ø25x2,35mm L=30mm	Pos. 13 Name: Nut 8 B Quantity: 4 Dim.: M12	Pos. 19 Name: Body of the automat Quantity: 1
			
Pos. 2 Name: Tow ball Quantity: 1	Pos. 8 Name: Washer Quantity: 4 Dim.: Ø58xØ12x6mm	Pos. 14 Name: Plain washer Quantity: 8 Dim.: Ø 13 mm	Pos. 20 Name: Body plug Quantity: 1
			
Pos. 3 Name: Socket plate Quantity: 1	Pos. 9 Name: Bolt 8,8 B Quantity: 4 Dim.: M12x25mm	Pos. 15 Name: Plain washer Quantity: 4 Dim.: Ø 10,5 mm	Pos. 21 Name: Washer Quantity: 2 Dim.: Ø30xØ10.5x2.5mm
			
Pos. 4 Name: Right bracket Quantity: 1	Pos. 10 Name: Bolt 8,8 B Quantity: 4 Dim.: M12x35mm	Pos. 16 Name: Spring washer Quantity: 8 Dim.: Ø 12,2 mm	
			
Pos. 5 Name: Left bracket Quantity: 1	Pos. 11 Name: Bolt 8,8 B Quantity: 2 Dim.: M10x60mm	Pos. 17 Name: Spring washer Quantity: 6 Dim.: Ø 10,2 mm	
			



PPUH AUTO-HAK S.J.

Produkcja Zaczepów Kulowych
Henryk & Zbigniew Nejman
76-200 SŁUPSK ul. Słoneczna 16K
tel/fax (059) 8-414-414; 8-414-413
E-mail: office@autohak.com.pl
www.autohak.com.pl

Towing hitch (without electrical set)

Class: **A50-X** Cat. no. **Y22A**

Designed for:

Manufacturer: **HONDA**

Model: **ACCORD**

Type: **4/5 doors**

produced since 1993 till 10.1998

Technical data:

D-value: 7,91 kN

maximum trailer weight: **1400 kg**

maximum vertical cup load: **70 kg**

Approval number according to Directive 94/20/EC: e20*94/20*0976*00

Foreword

This towing hitch is designed according to rules of safety traffic regulations. The towing hitch is a safety component and can be install only by qualified personnel. Any alteration or conversion of the towing hitch is prohibited and would lead to cancellation of design certification. Remove insulating compound and underseal from vehicle (if present) in the area of the matting surfaces of the towing hitch. The vehicle manufacturer's specifications regarding trailer load and max. vertical cup load are decisive for driving, and values for the towing hitch cannot be exceeded.

D-value formula:

$$\frac{\text{Max trailer weight [kg]} \times \text{Max vehicle weight [kg]}}{\text{Max trailer weight [kg]} + \text{Max vehicle weight [kg]}} \times \frac{9,81}{1000} = D \text{ [kN]}$$